

Yoshi

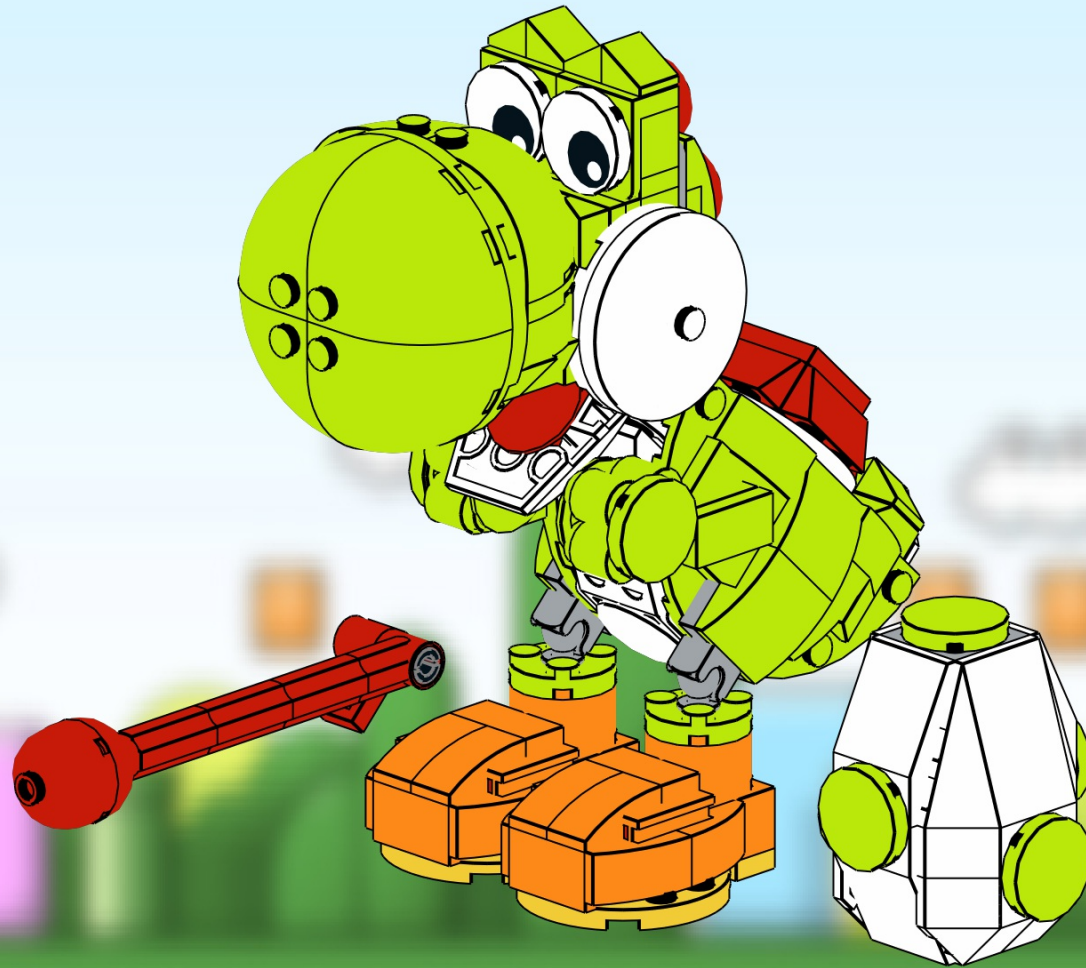

247 pcs.

51 Pages

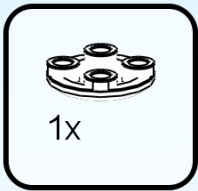
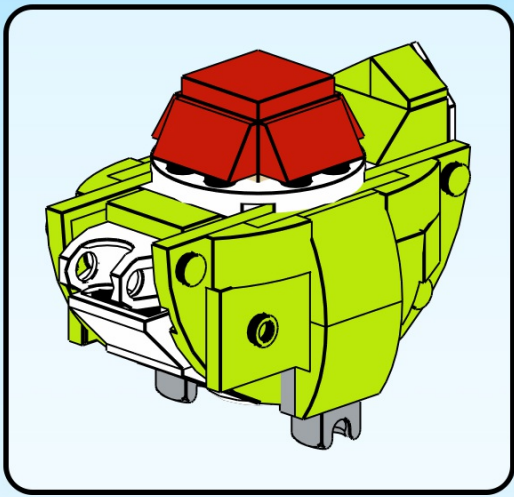

1

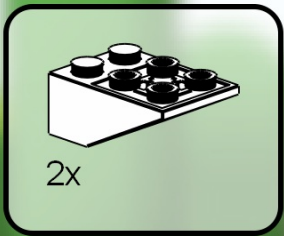

2

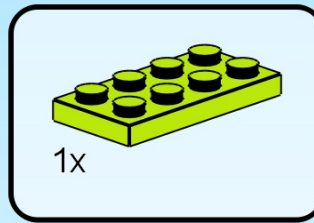
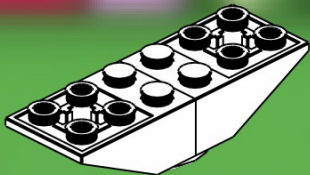

3

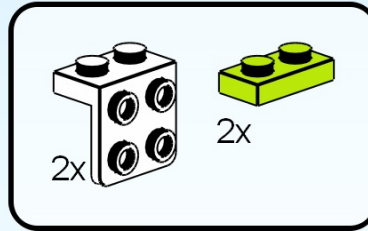
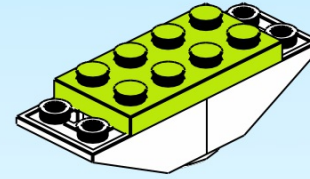

4

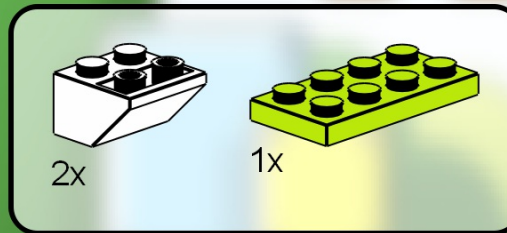
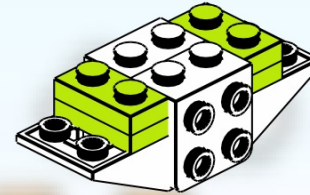

5

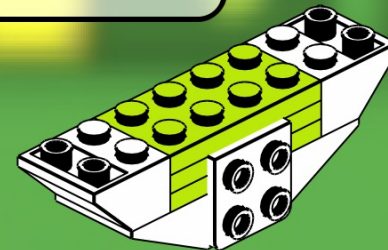

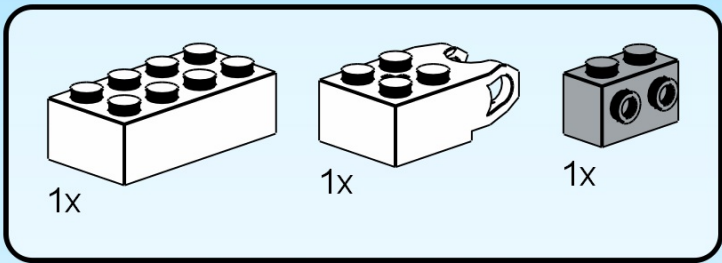

6

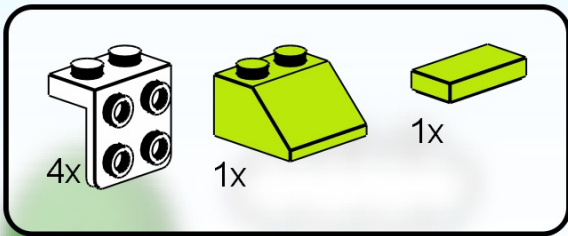
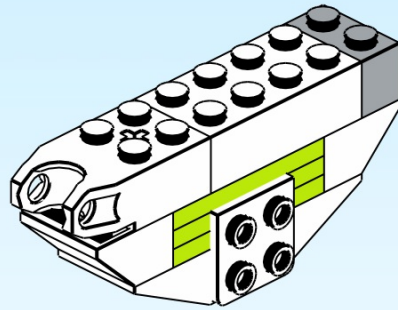

7

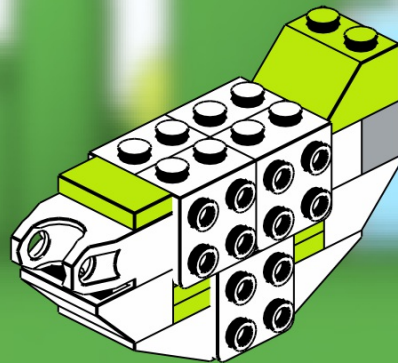

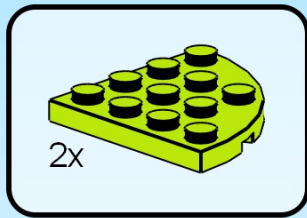
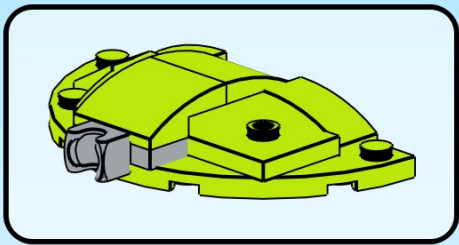

1

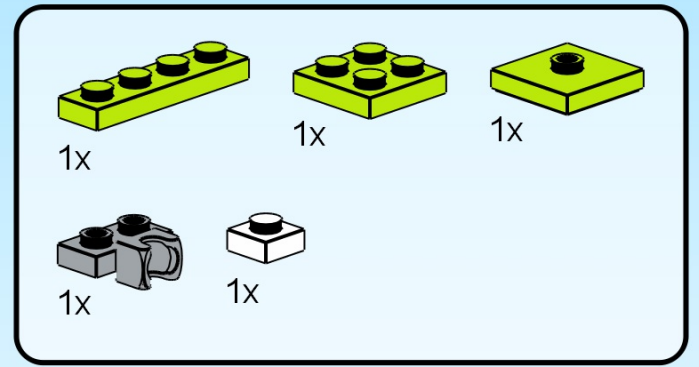
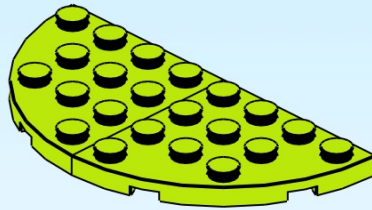

2

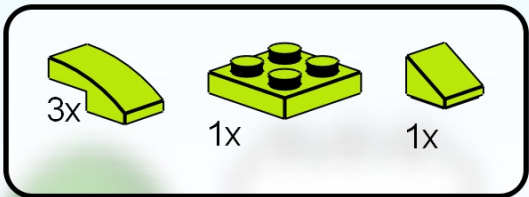
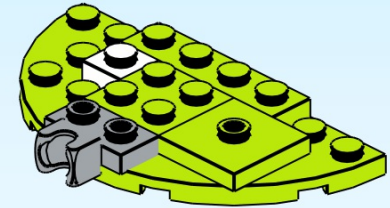

3

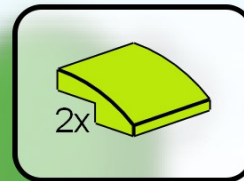
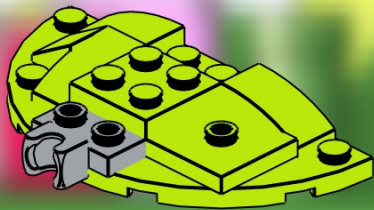

4

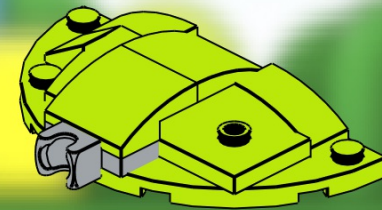

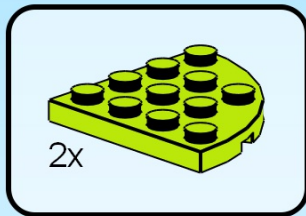
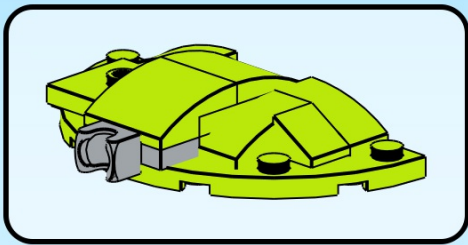

1

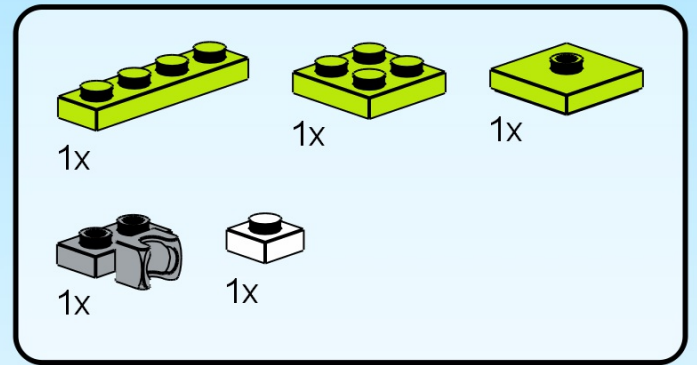
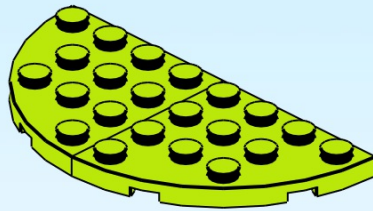

2

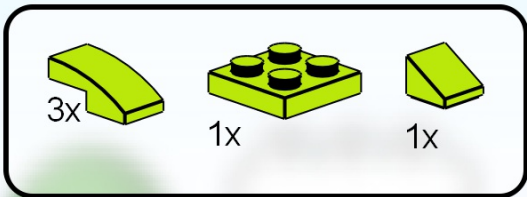
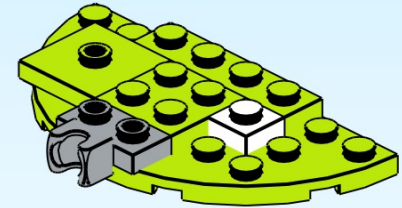

3

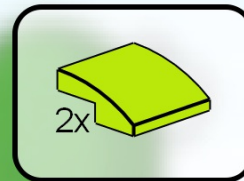
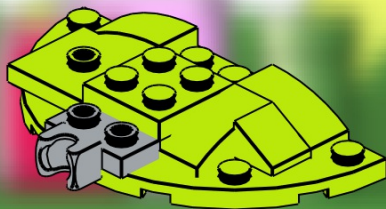

4

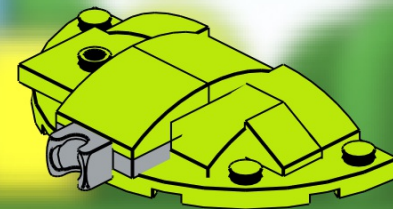

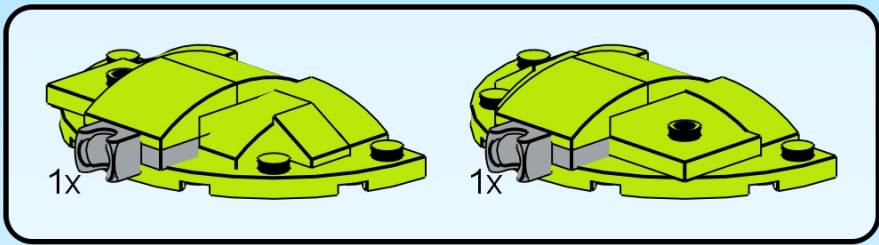

8

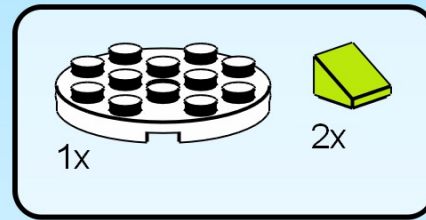
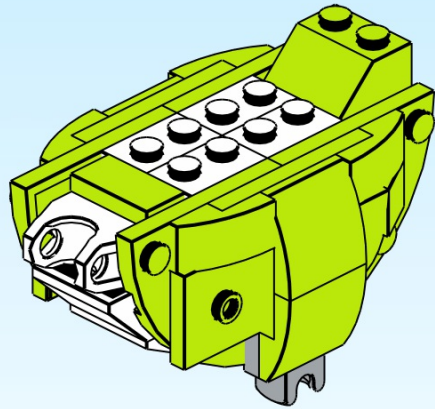

9

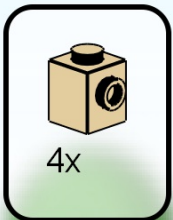
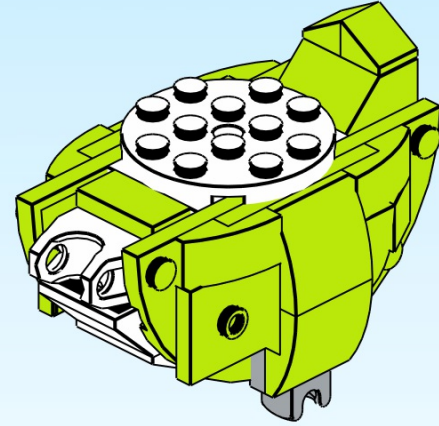

10

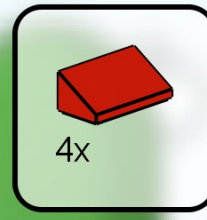
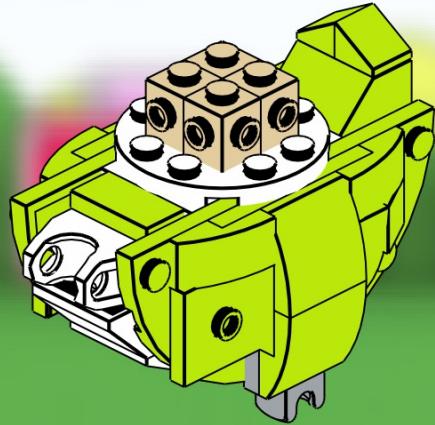

11

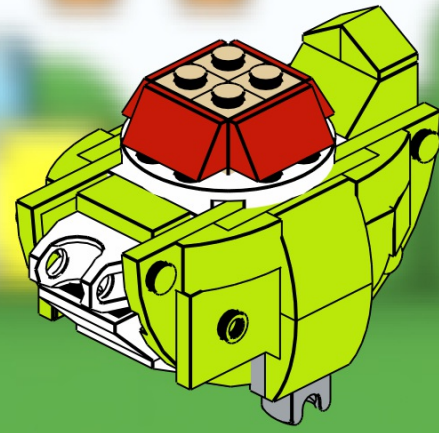

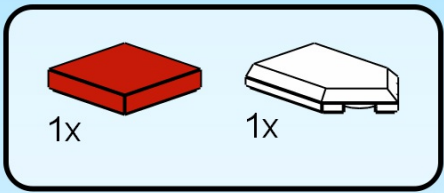

12

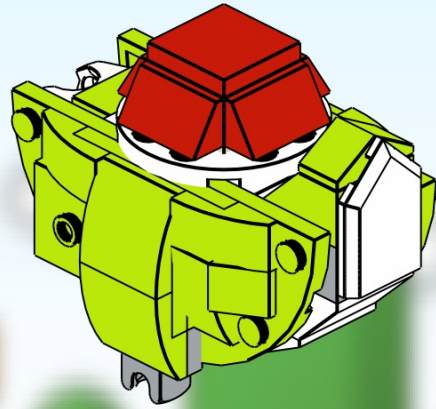
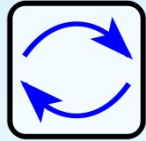

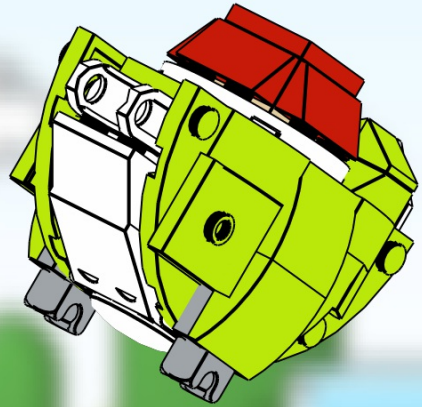
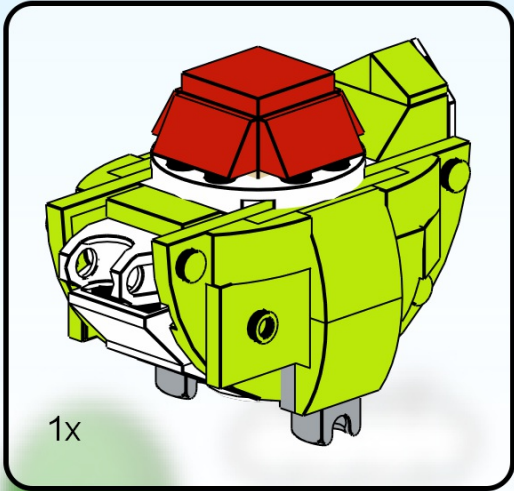
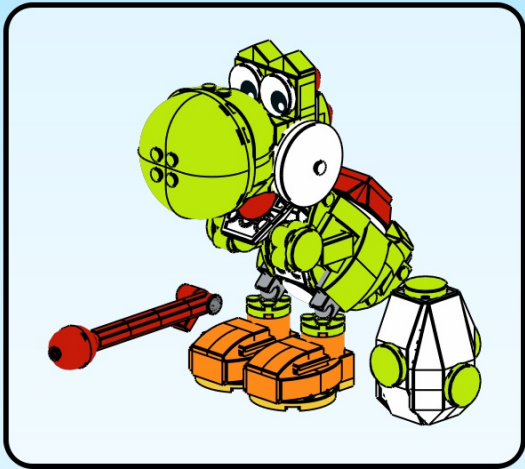

1

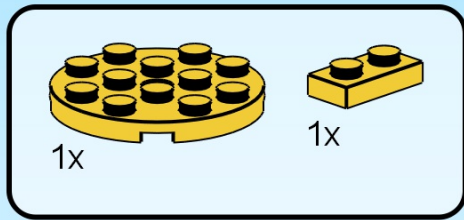
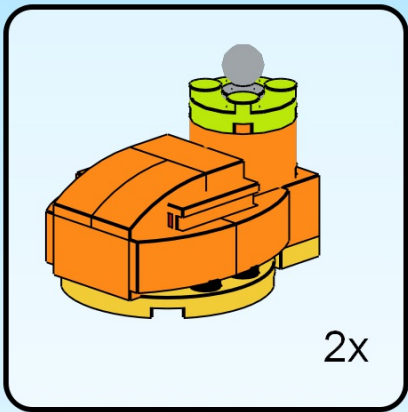

1

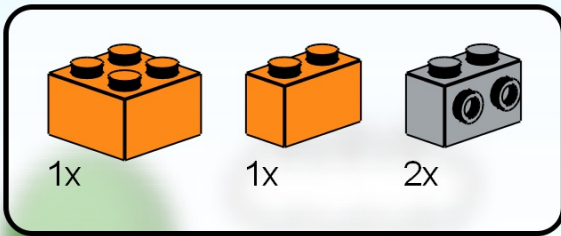
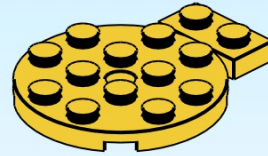

2

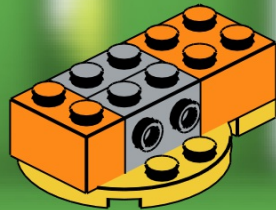

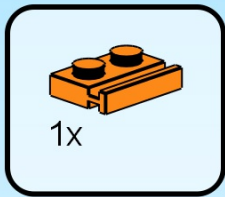
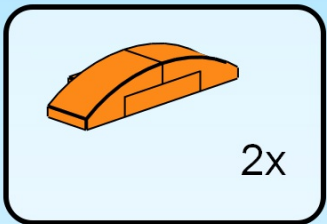

1

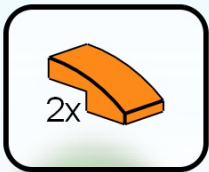
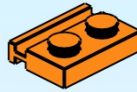

2



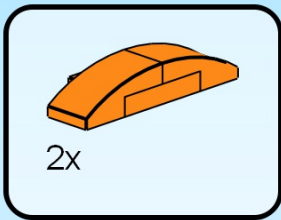

3

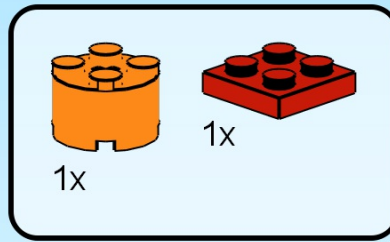
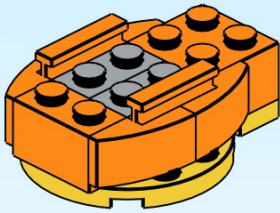

4

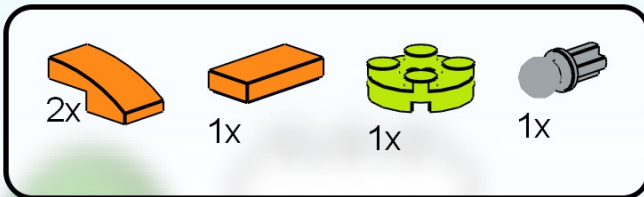
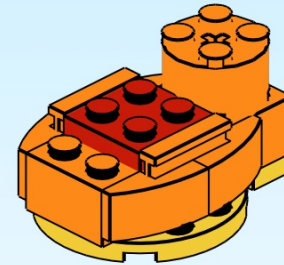

5

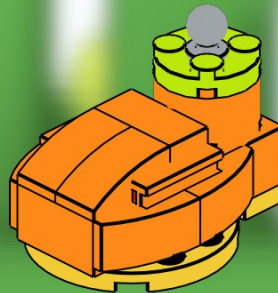

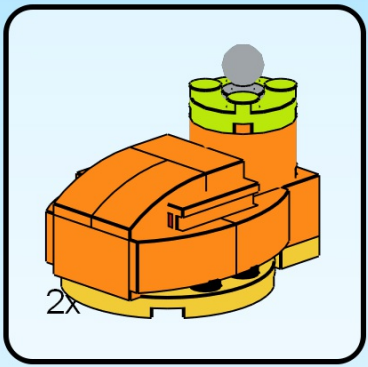

2

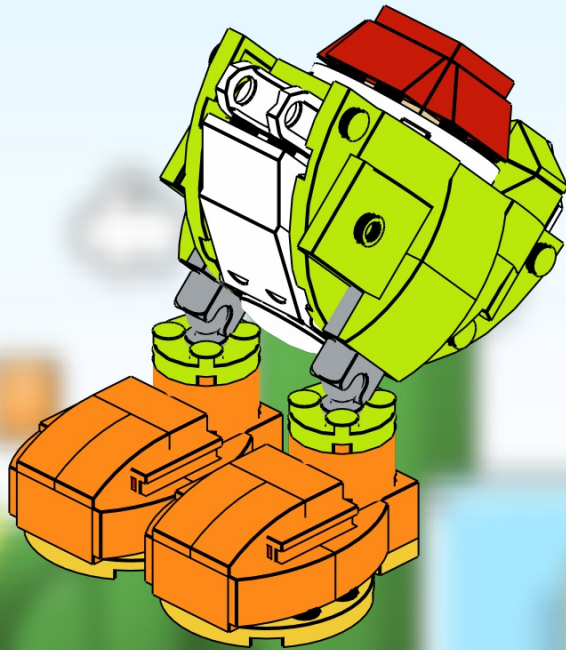

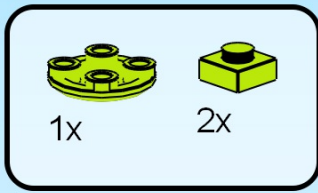
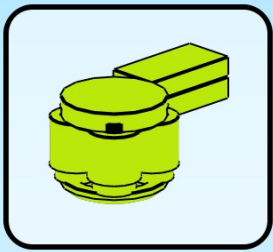

1

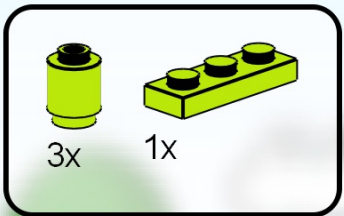

2

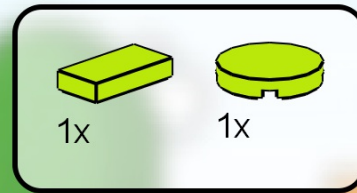

3

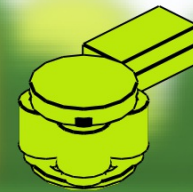

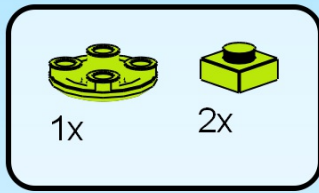
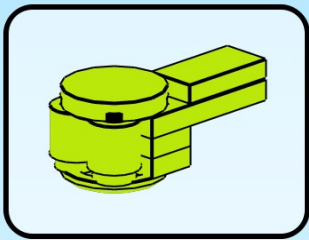

1

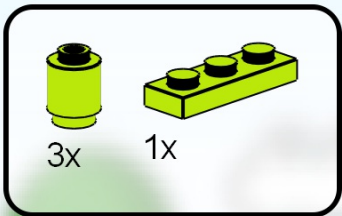
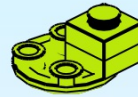

2

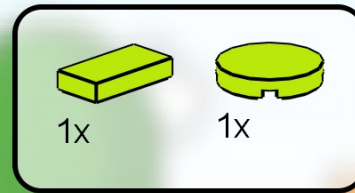
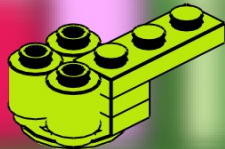

3

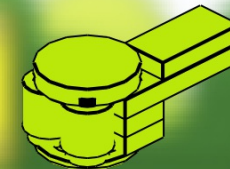

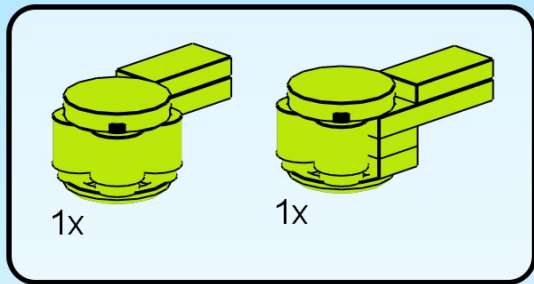

3

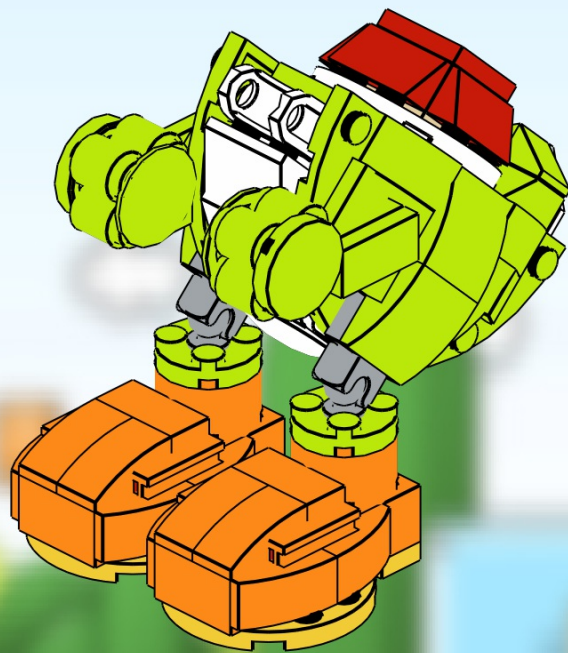

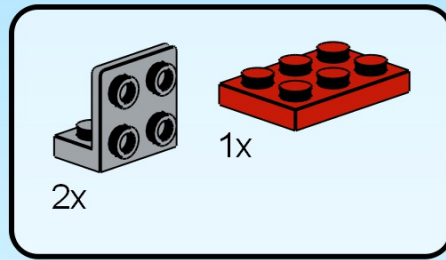
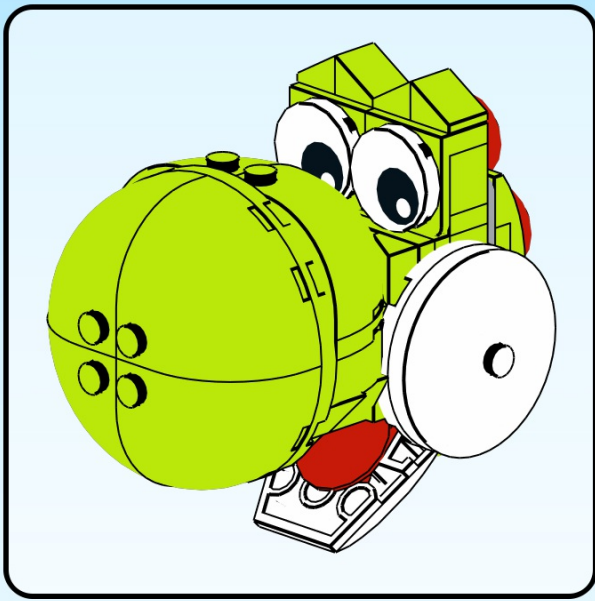

1

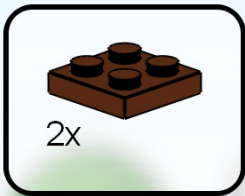
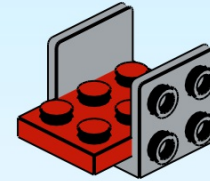

2

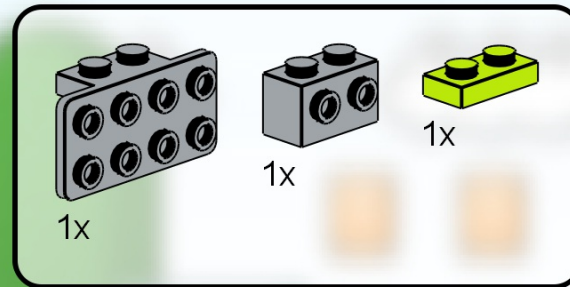
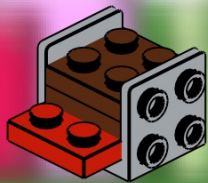

3

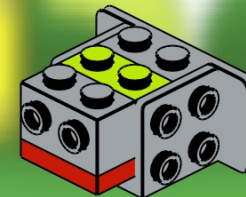

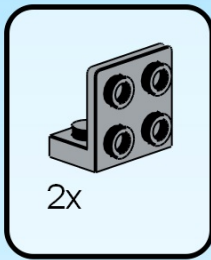
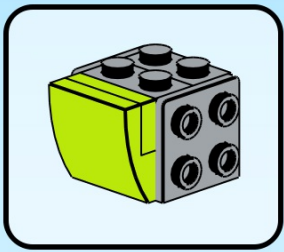

1

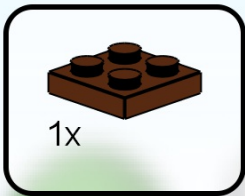
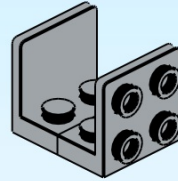

2

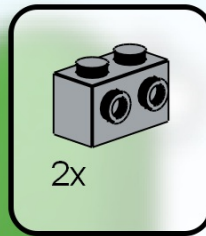
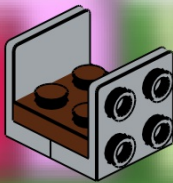

3

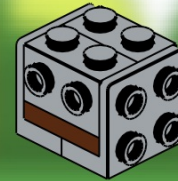

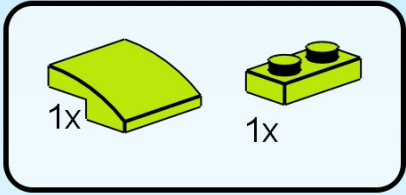
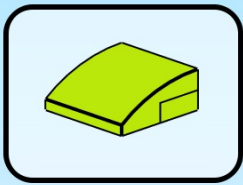

1



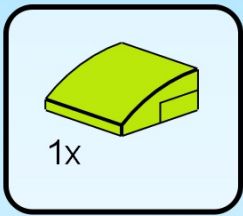

4

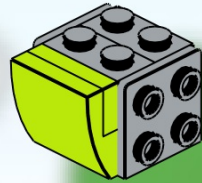

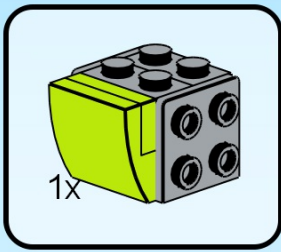

4

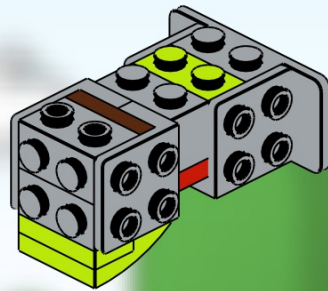

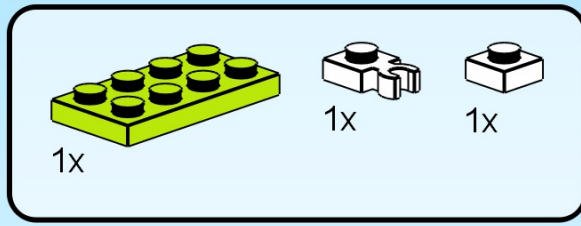
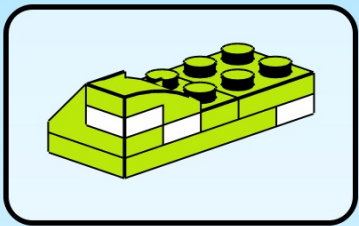

1

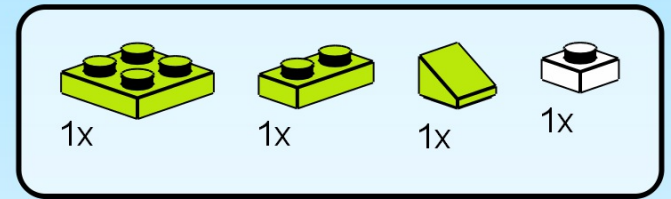
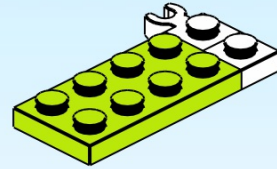

2

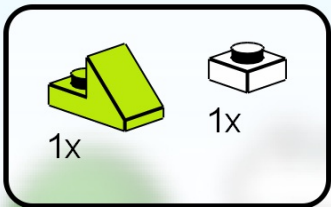
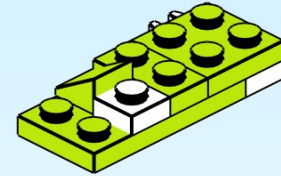

3

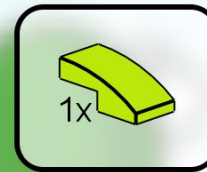
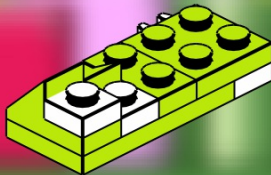

4

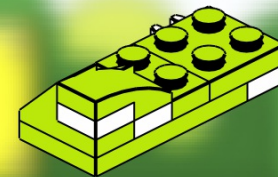

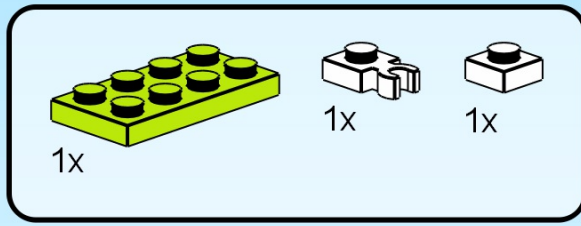
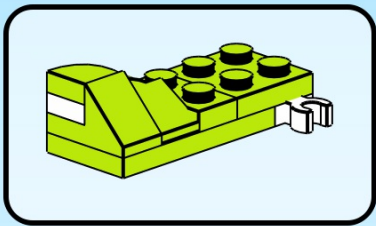

1

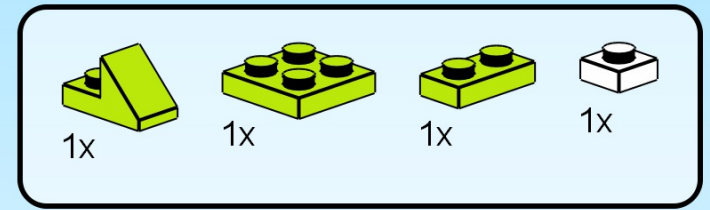
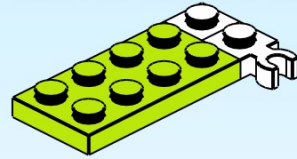

2

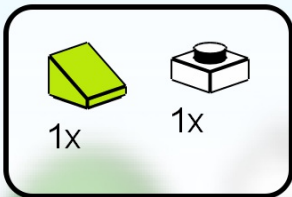
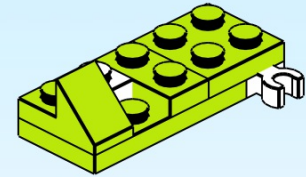

3

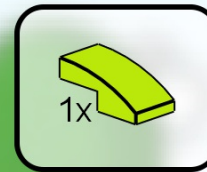
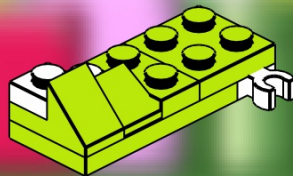

4

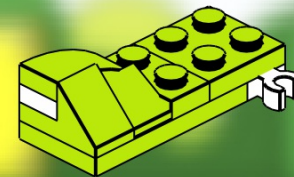

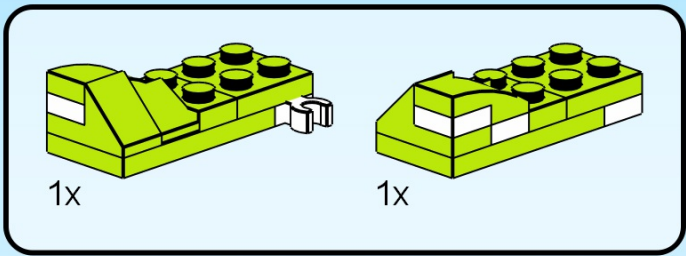

5

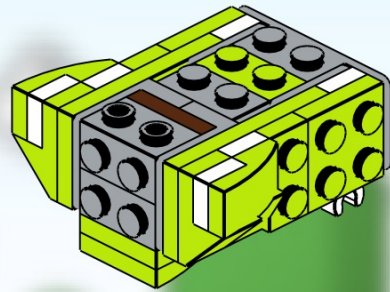

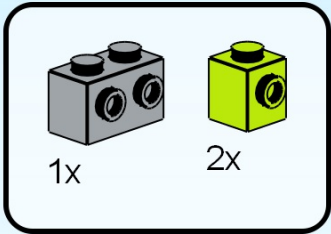
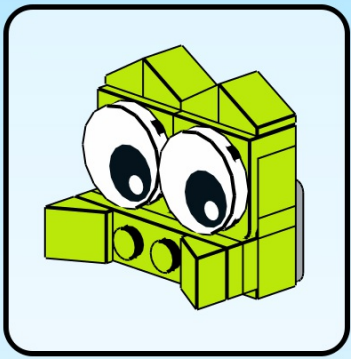

1

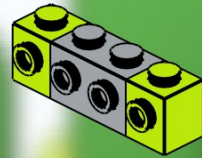

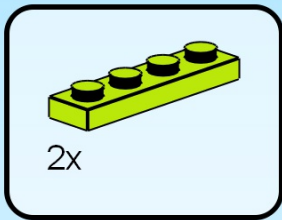
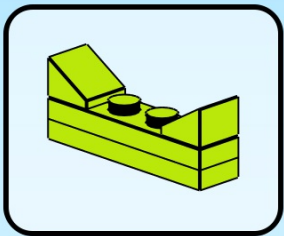

1

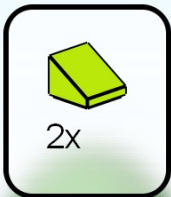
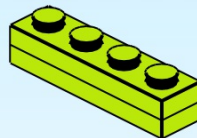

2

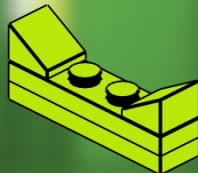

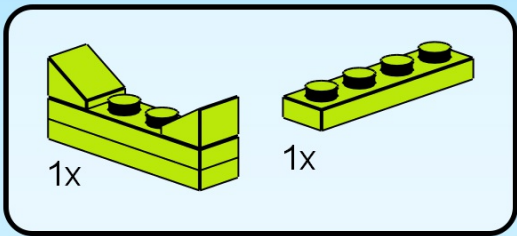

2

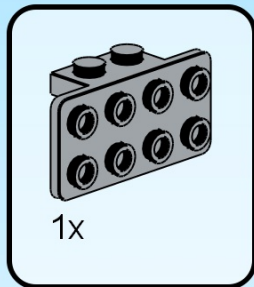
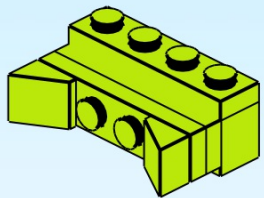

3

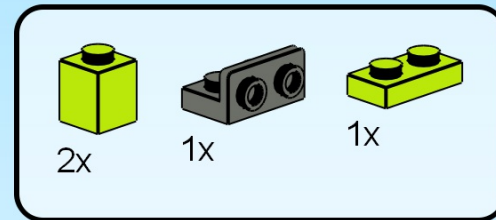
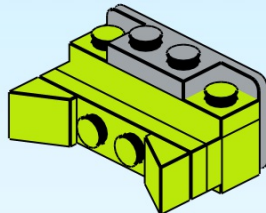

4

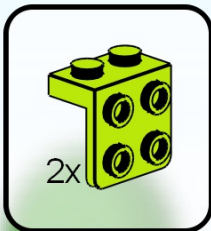
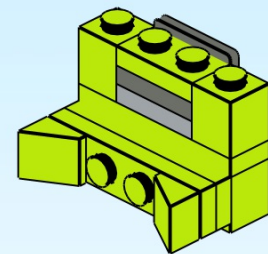

5

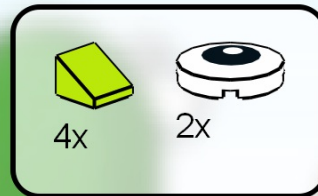
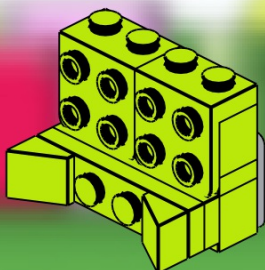

6

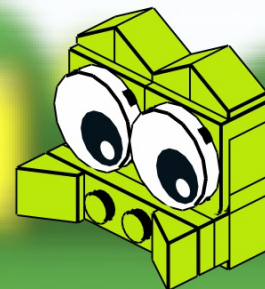

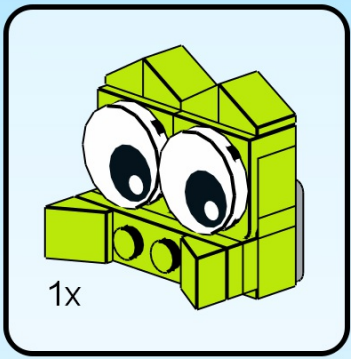

6

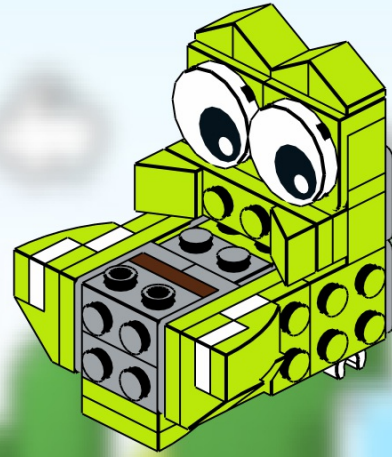

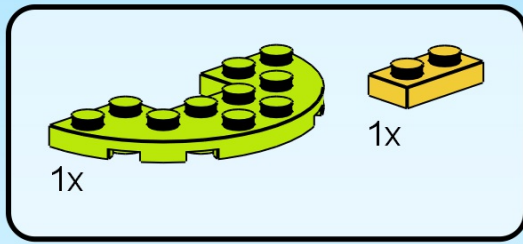
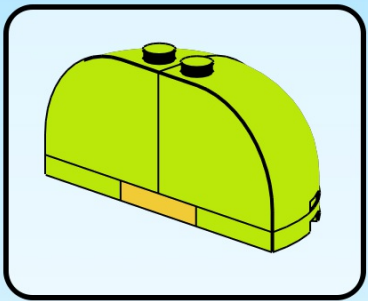

1

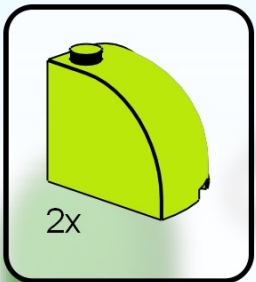
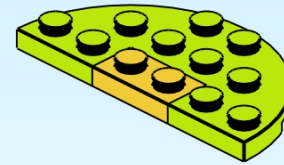

2

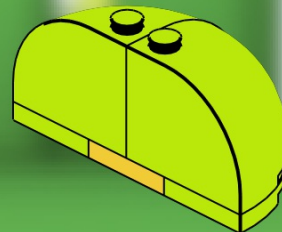

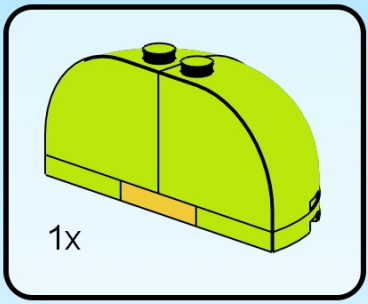

7

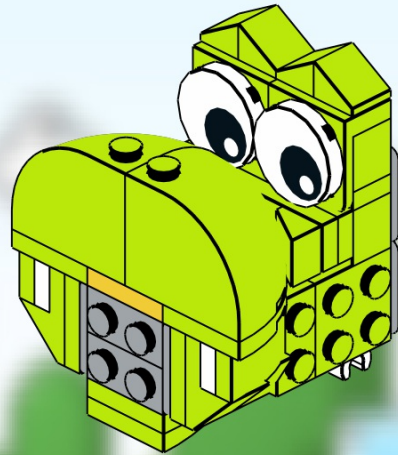

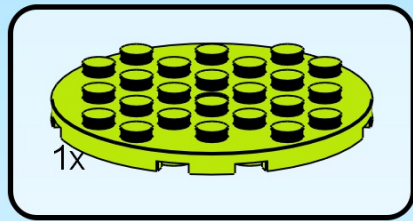
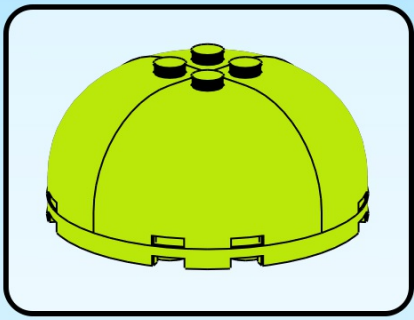

1

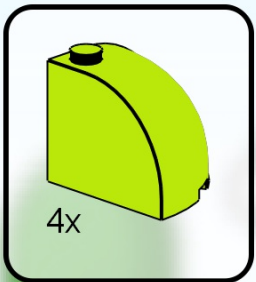
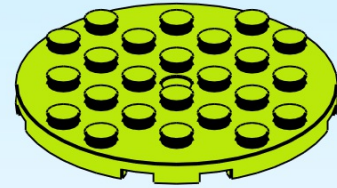

2

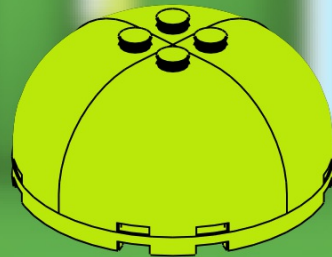

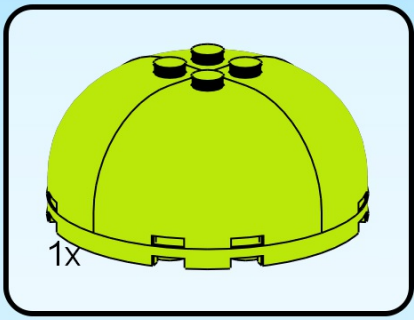

8

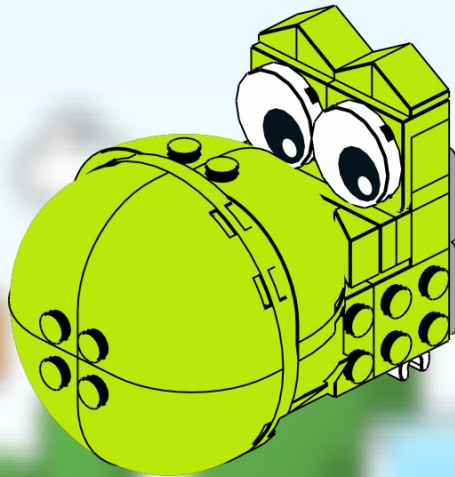

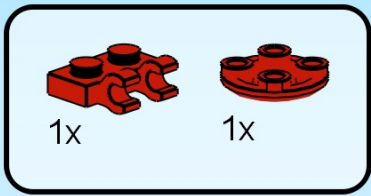
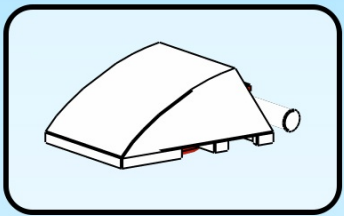

1

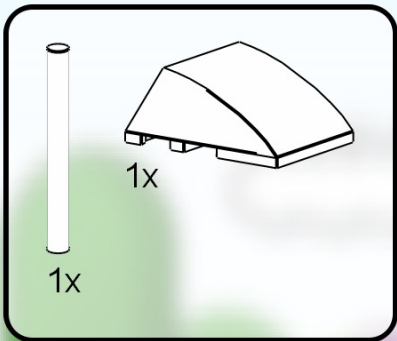

2



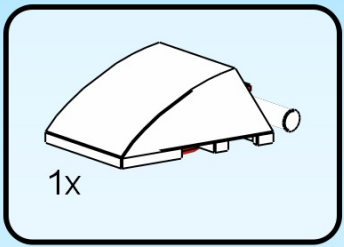

9

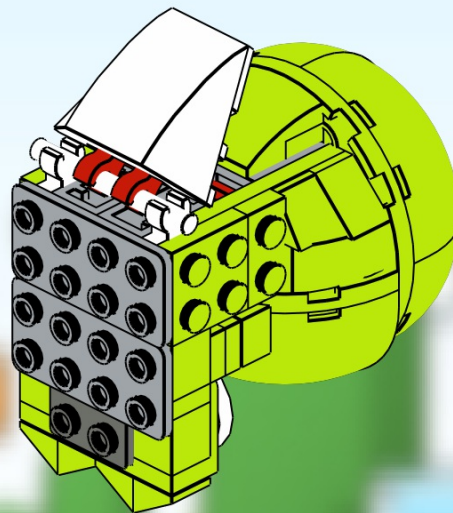
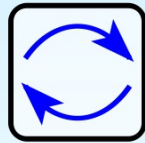

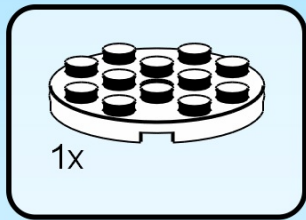
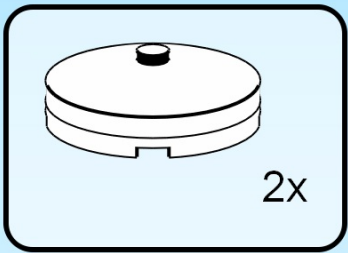

1

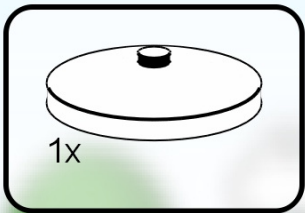
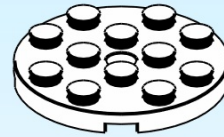

2

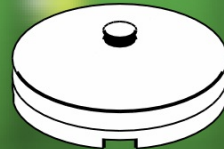

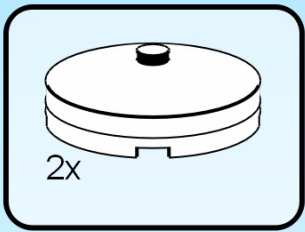

10

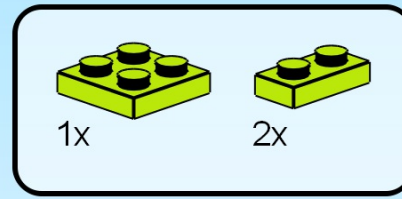

11

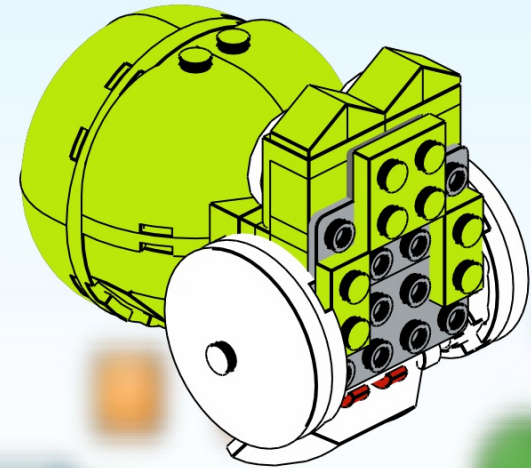
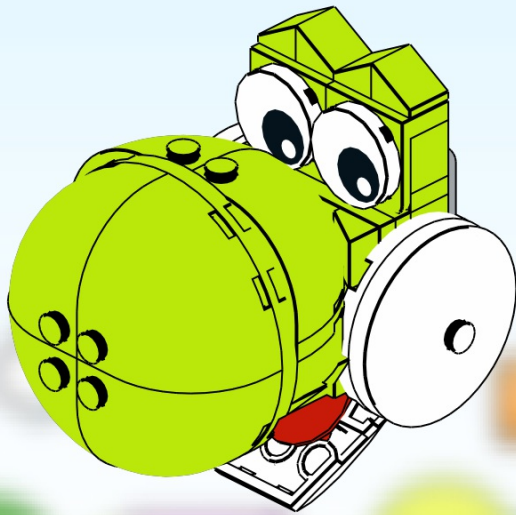
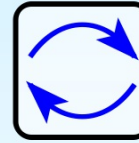

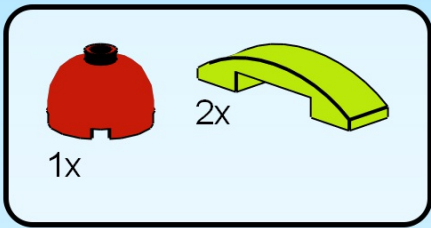

12

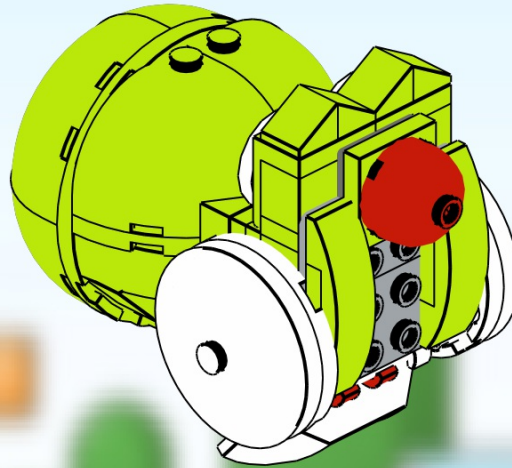

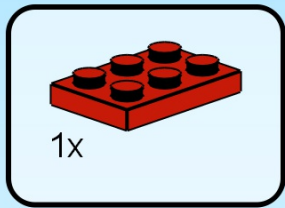
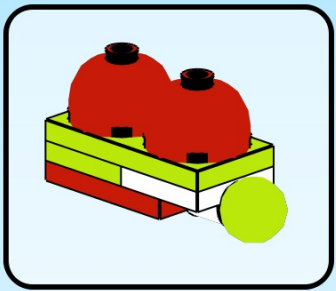

1

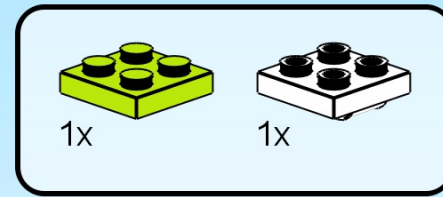
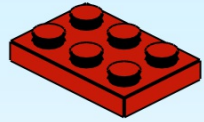

2

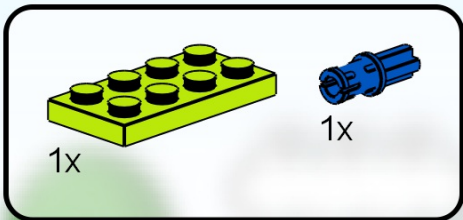
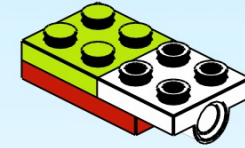

3

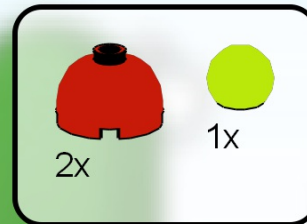
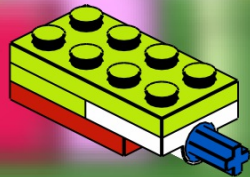

4

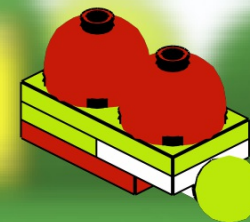

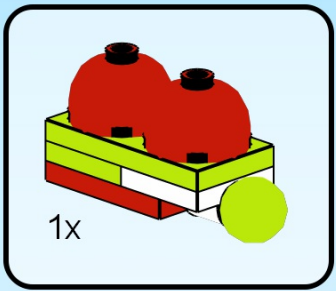

13

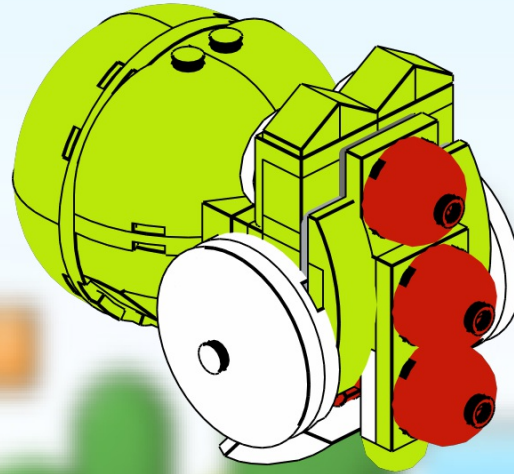

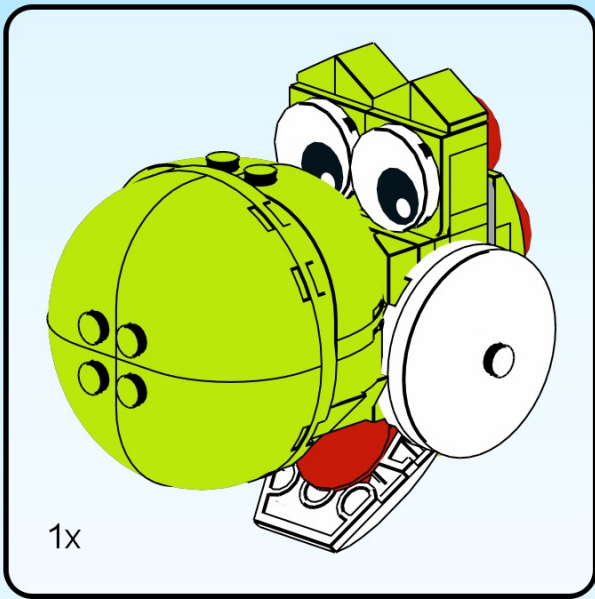

4

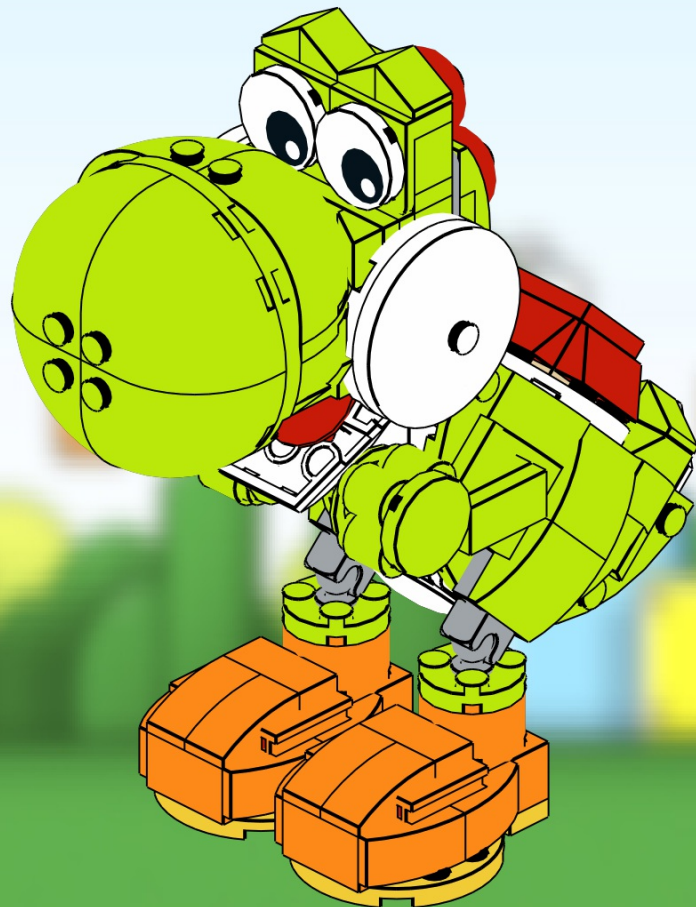

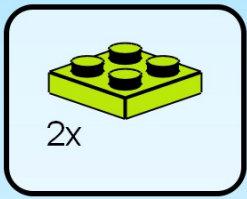
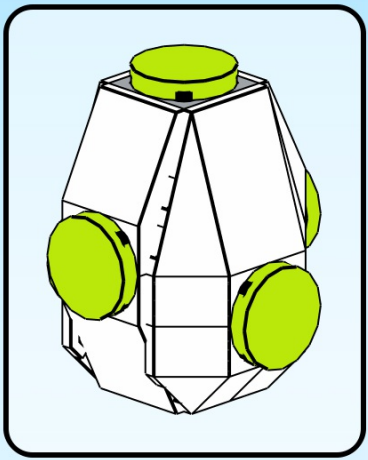

1

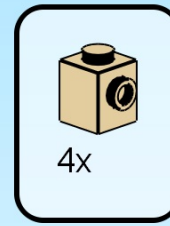
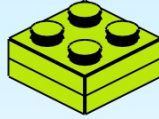

2

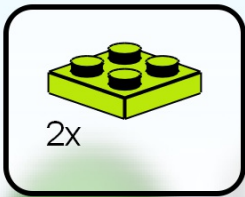
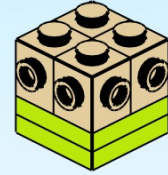

3

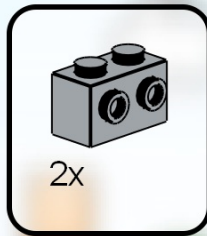

4

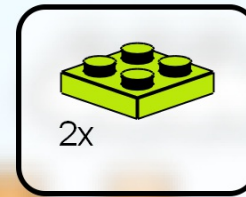
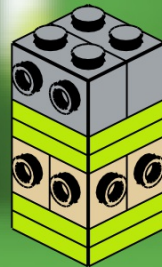

5

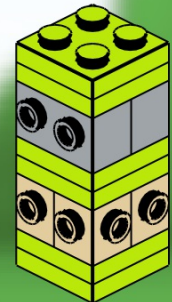

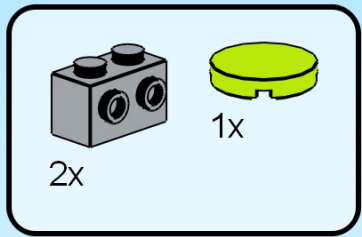

6

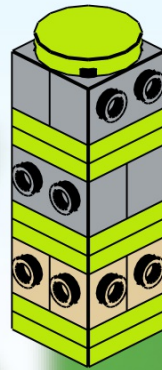

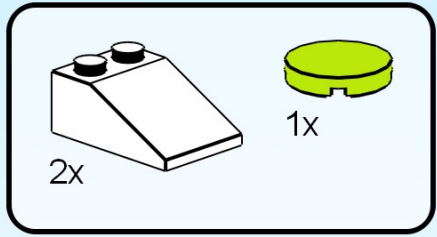
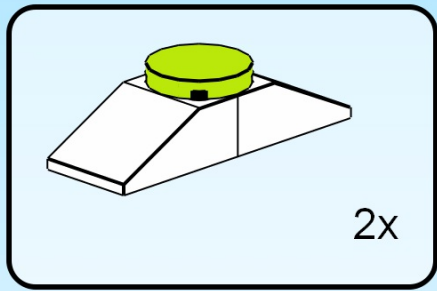

1

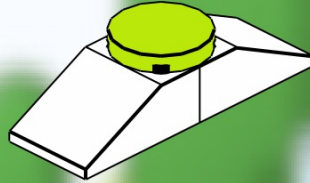

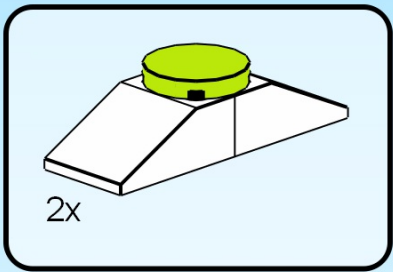

7

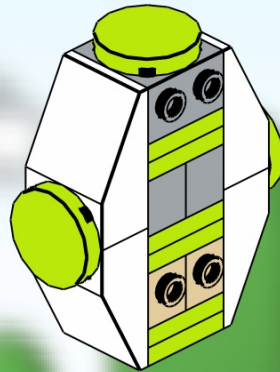

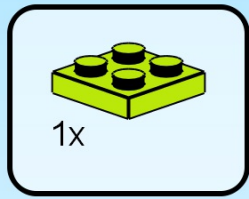
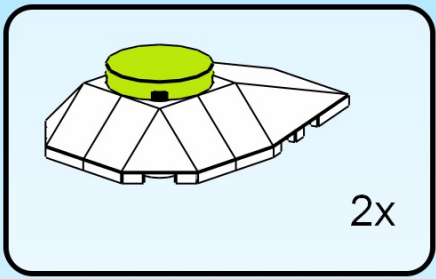

1

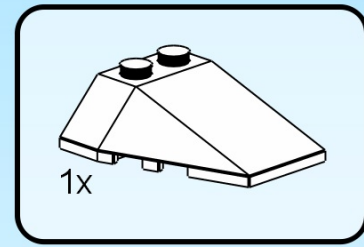

2

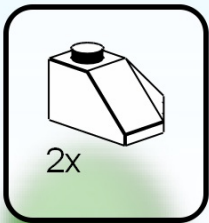
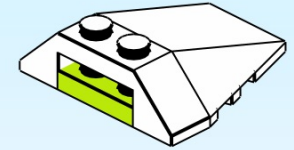
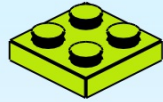

3

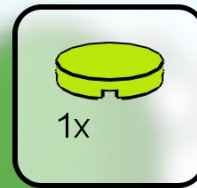
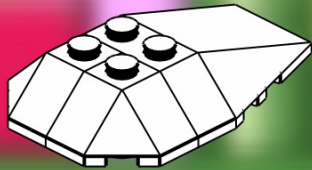

4

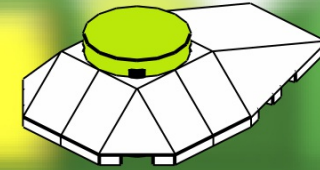

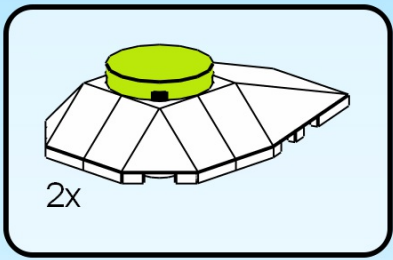

8

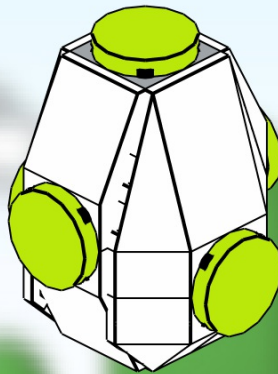

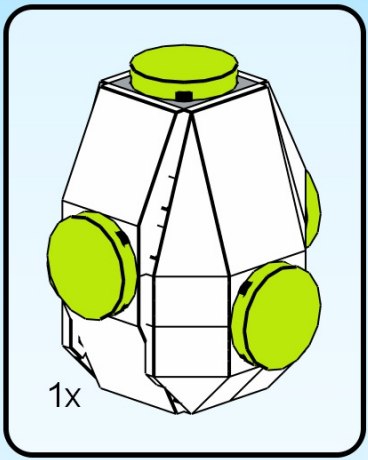

5

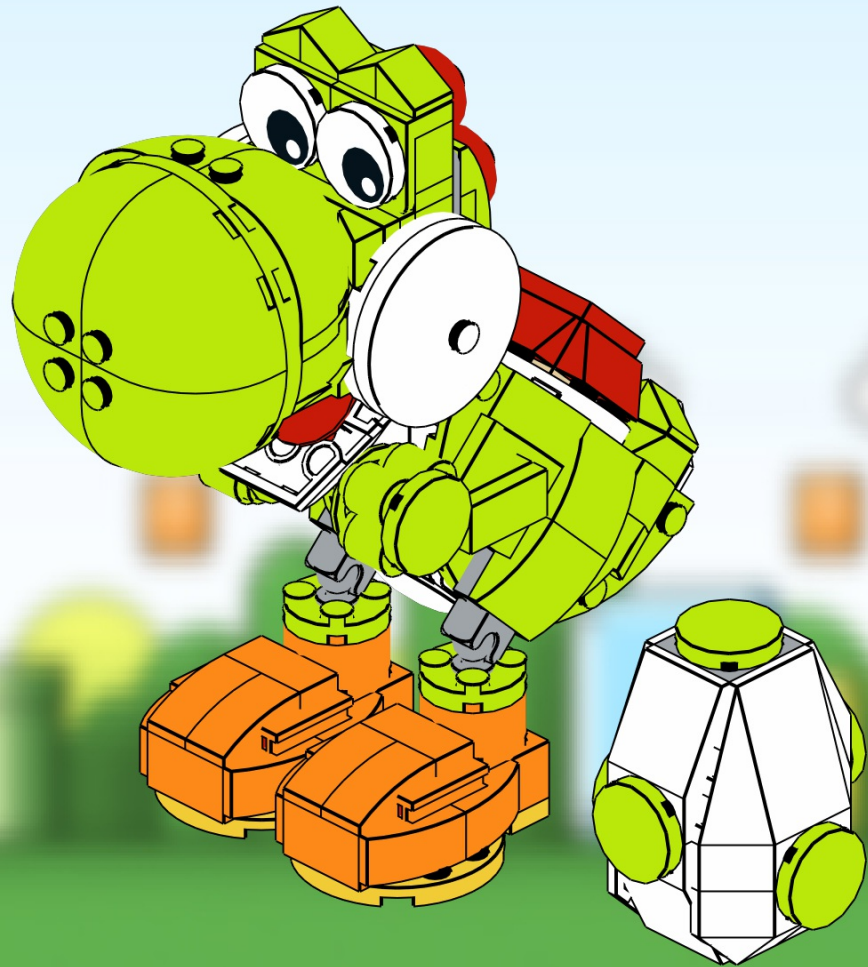

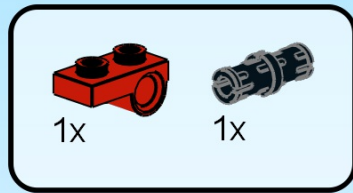
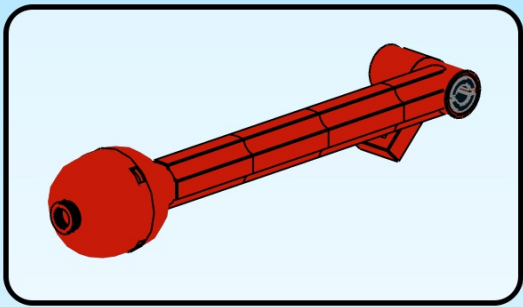

1

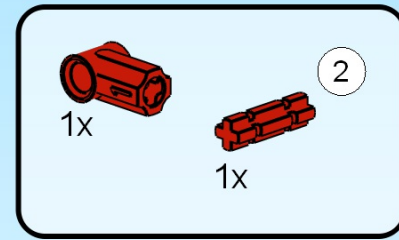

2

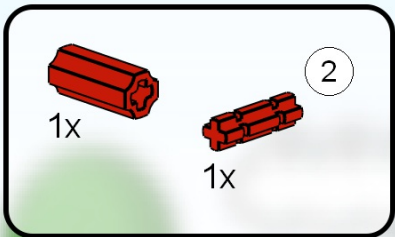

3

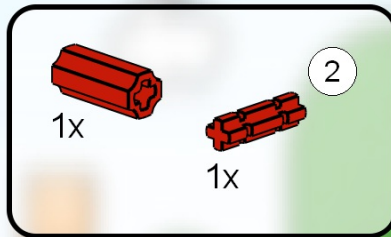
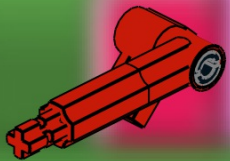

4

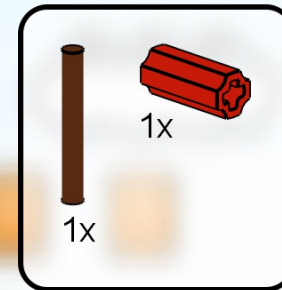
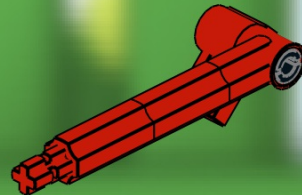

5

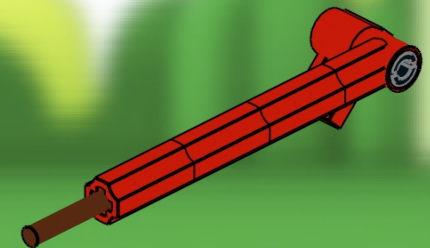

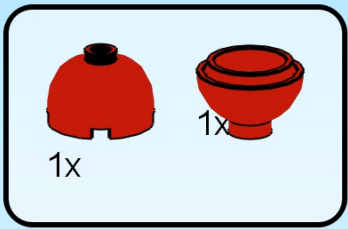

6

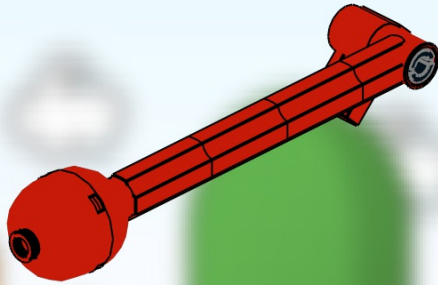

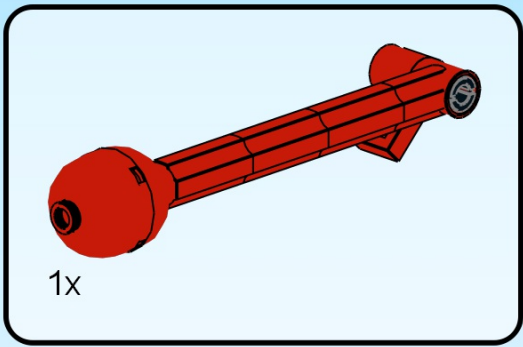

6

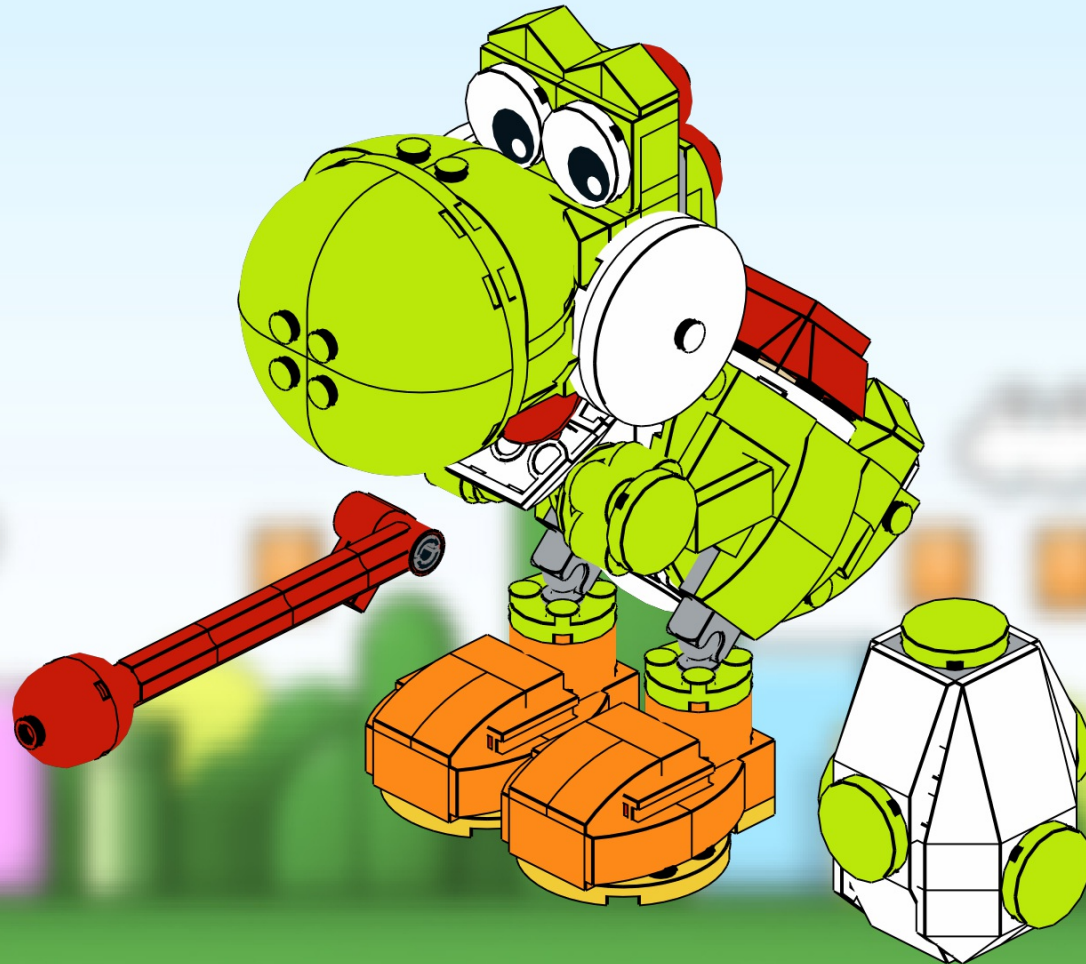

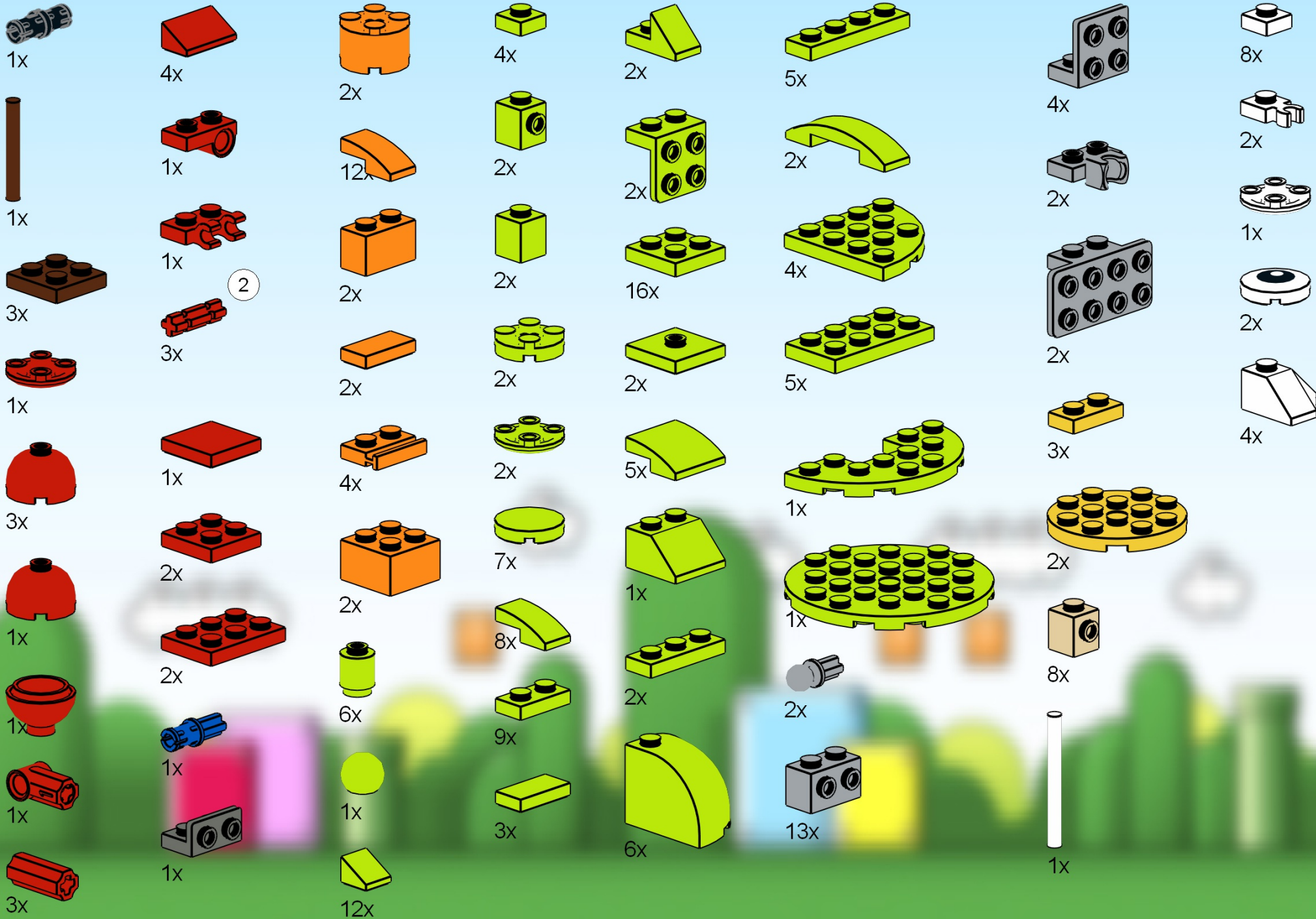



6x



2x

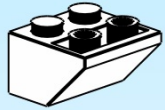

2x

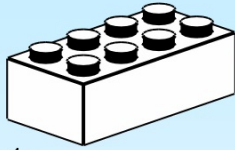

1x



1x

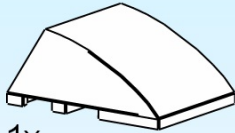

1x



1x

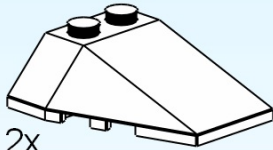

2x

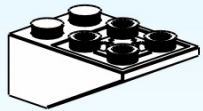

2x

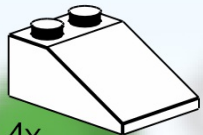

4x



1x



3x